

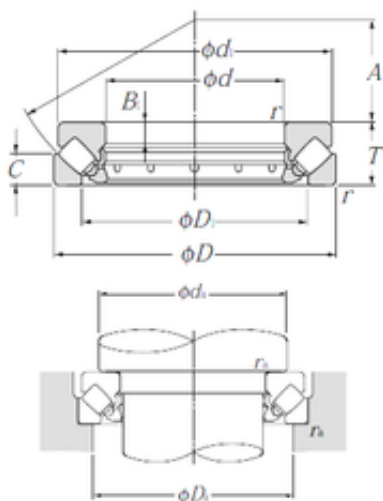

NTN BEARING-BOWER CORP.

NTN 29368 Thrust Bearings

Bearing No. 29368



29368 Bearing 2D drawings and 3D CAD models

Size	340x540x122 mm
Bore Diameter	340 mm
Outer Diameter	540 mm
Width	122 mm
d	340 mm
D	540 mm
T	122 mm
B1	41 mm
C	59 mm
d1	520 mm
r min.	5 mm
A	192 mm
D1	428 mm
da min.	430 mm
Da max.	470 mm
ra max.	4 mm
Weight	107 Kg
Basic dynamic load rating (C)	2 650 kN
Basic static load rating (C0)	10 700 kN