

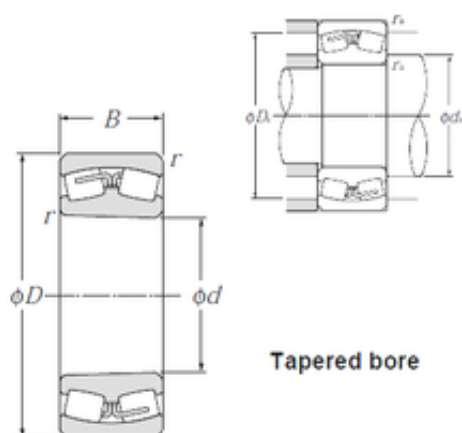

NTN BEARING-BOWER CORP.

1060 mm x 1 500 mm x 325 mm NTN 230/1060BK Spherical Roller Bearings



Bearing No. 230/1060BK

Size	1060x1500x325 mm
Bore Diameter	1060 mm
Outer Diameter	1500 mm
Width	325 mm
d	1060 mm
D	1 500 mm
B	325 mm
C	325 mm
r min.	9,5 mm
da min.	1 104 mm
Da max.	1 456 mm
ra max.	8 mm
Weight	1 790 Kg
Basic dynamic load rating (C)	13 600 kN
Basic static load rating (C0)	33 500 kN
(Grease) Lubrication Speed	150 r/min
(Oil) Lubrication Speed	200 r/min
Calculation factor (e)	0,2
Calculation factor (Y0)	3,28
Calculation factor (Y1)	3,36

230/1060BK Bearing 2D drawings and 3D CAD models